

Pokračuj ve zdobení ryby a dodržuj výchozí vzor.  
Pozor, nesmíš vybočit z řádků!

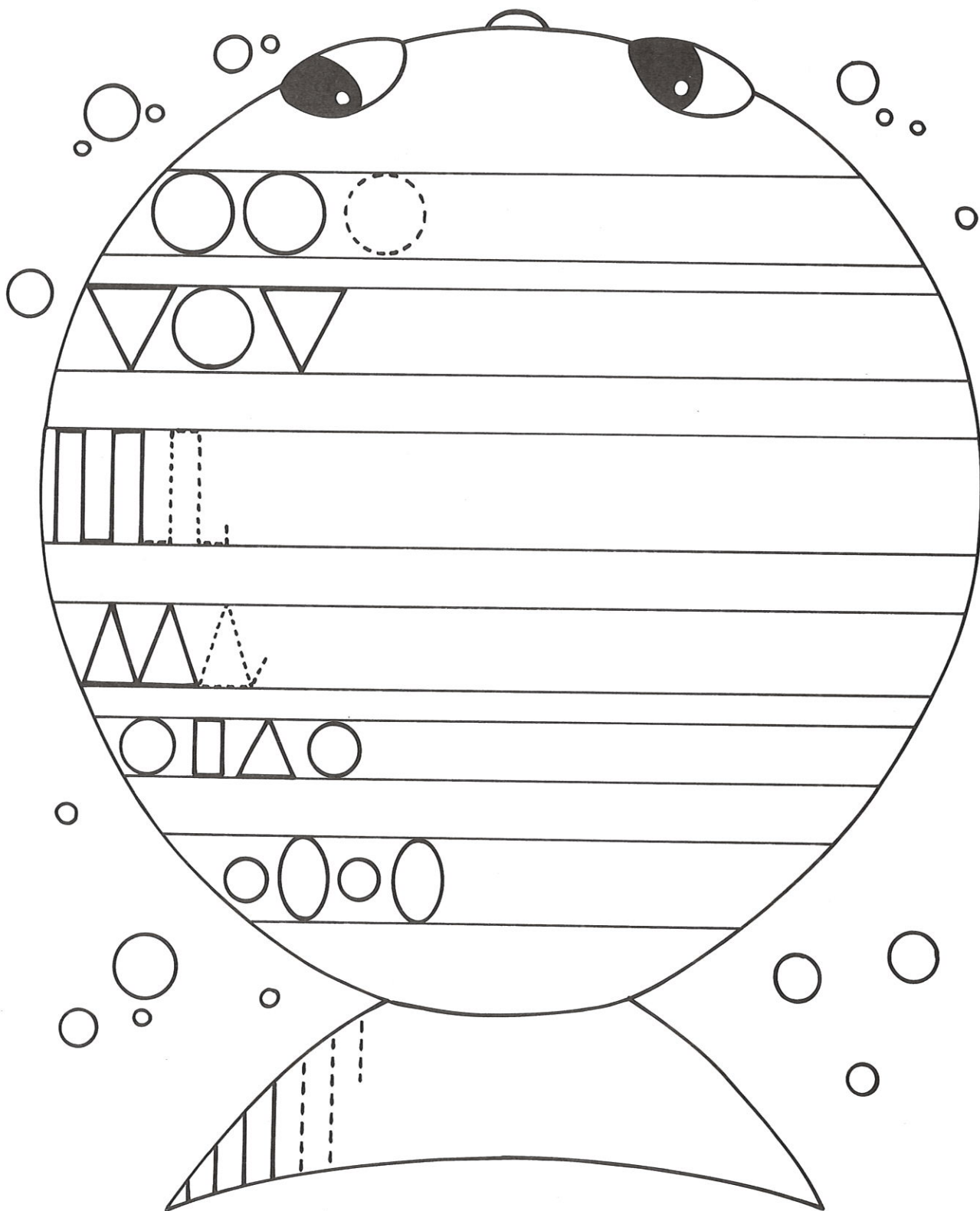

Děvčata sbírají cestou houby.

Na první houpačce je Evin košík těžší než Lauřin.

Na ostatních houpačkách dokresli správný počet hub.

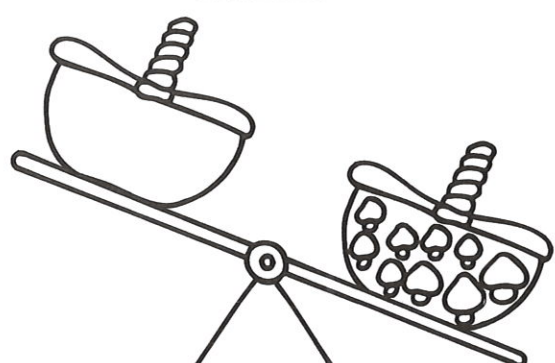
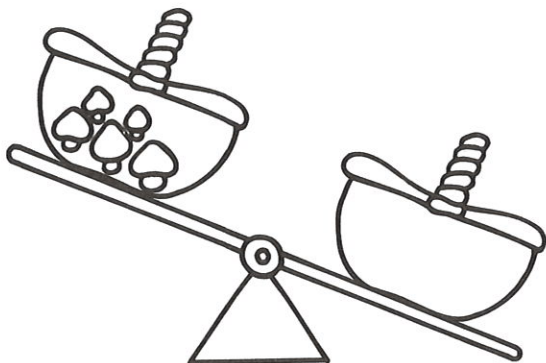
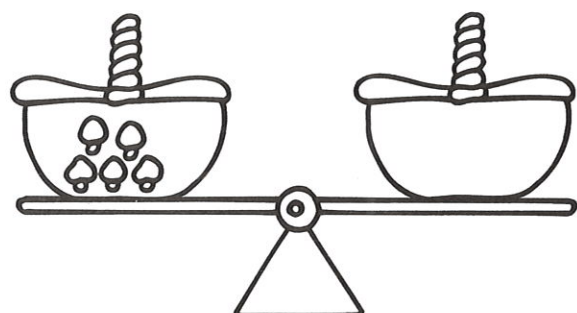
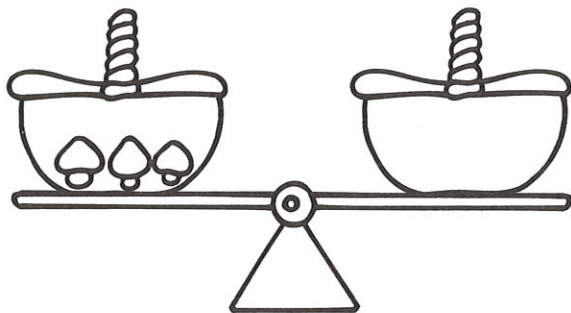
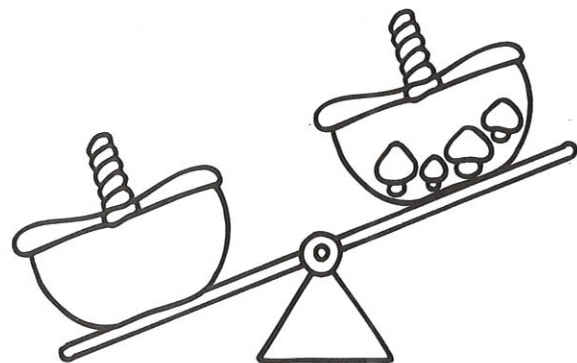
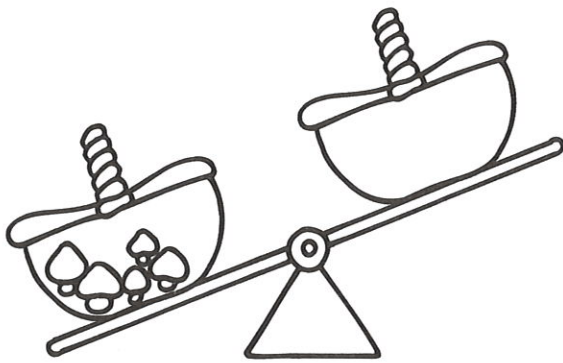
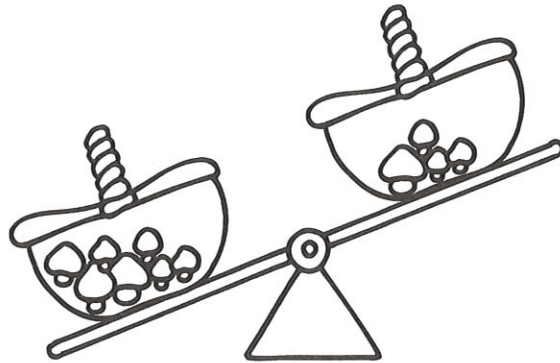

Děti jdou dům od domu a dostávají sladkosti.  
V každém řádku vybarvi dárek,  
v němž je toho nejméně.

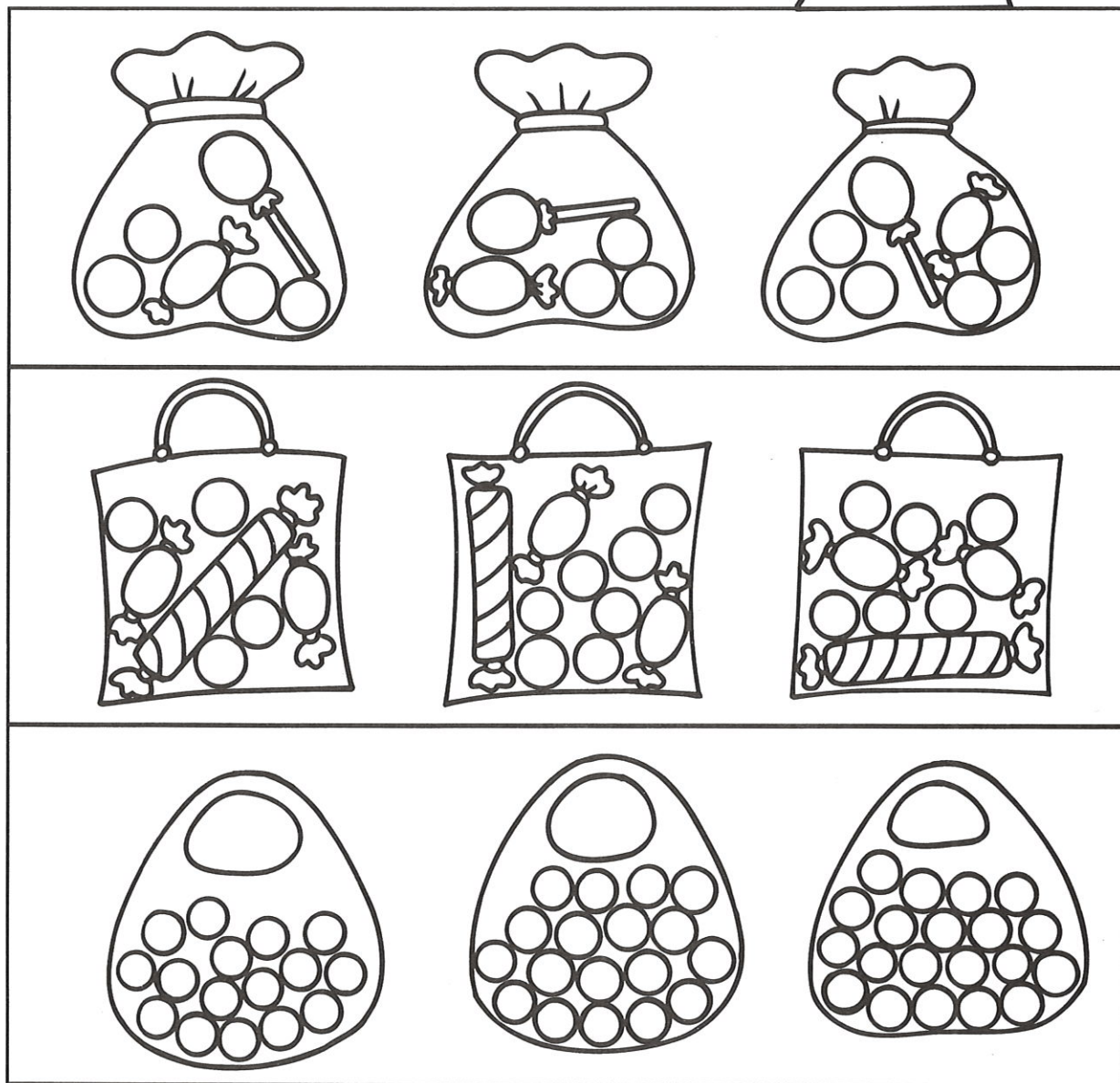



Říká se, že čtyřlístky přinášejí štěstí tomu, kdo je najde. Najdi mezi trojlístky 5 čtyřlístků a vybarvi je zelenou pastelkou.

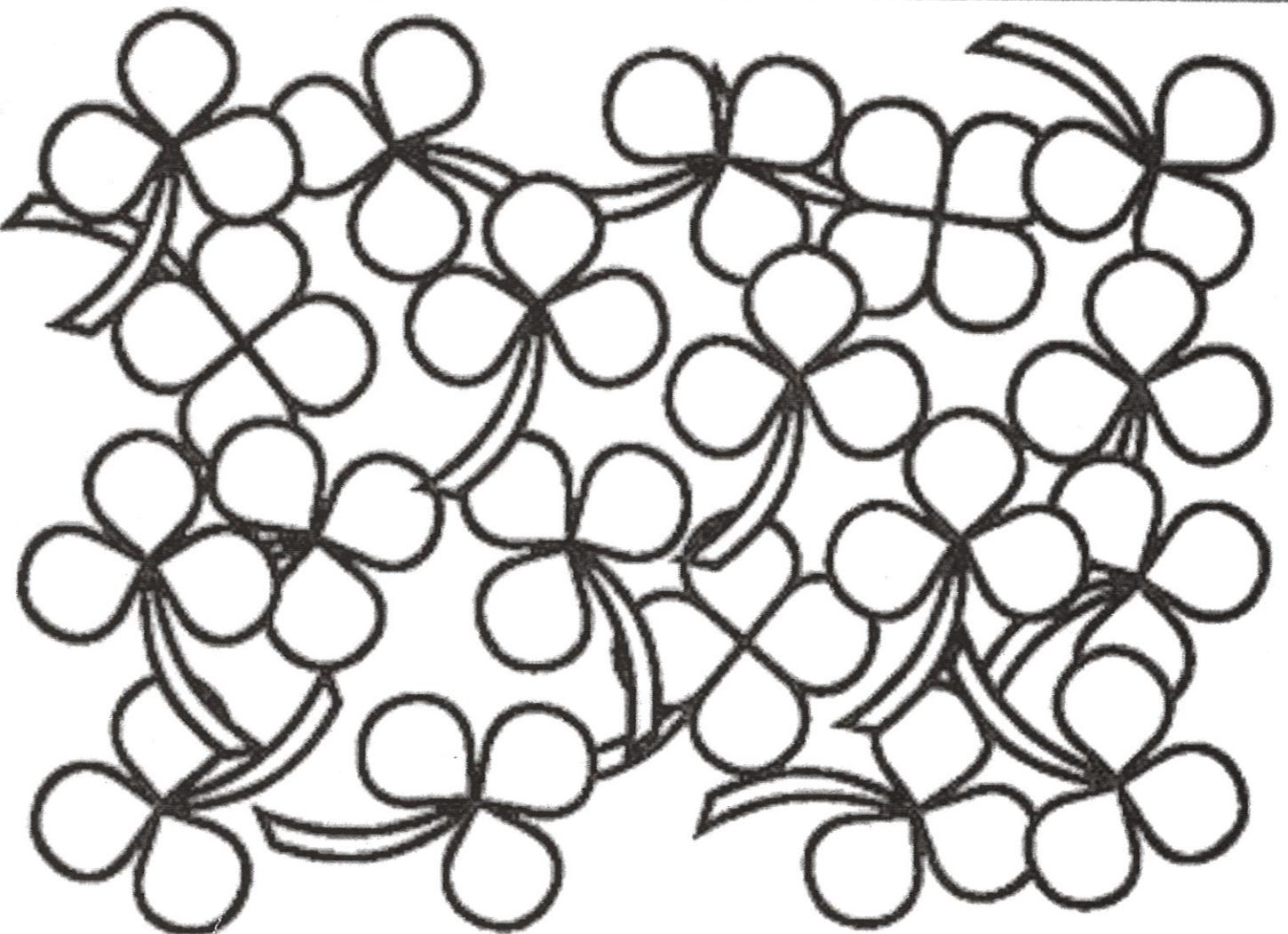



# VŽDY ZE VŠECH NEJMENŠÍ

Které z těchto zvířátek je ve skutečnosti nejmenší? V každém rámečku to nejmenší zvířátko vybarvi.

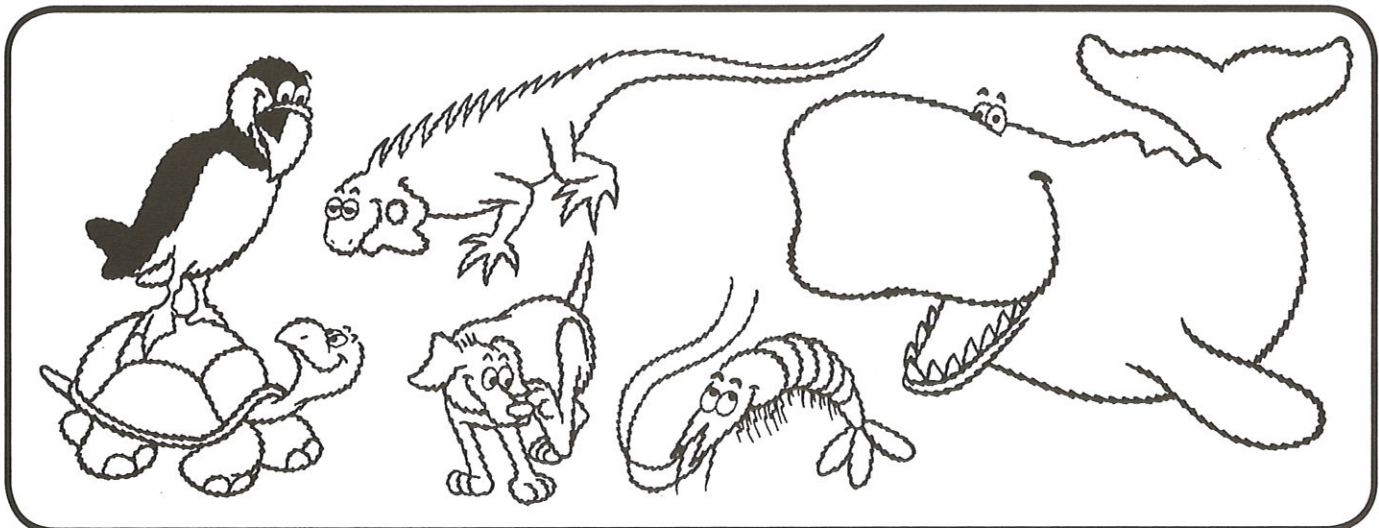
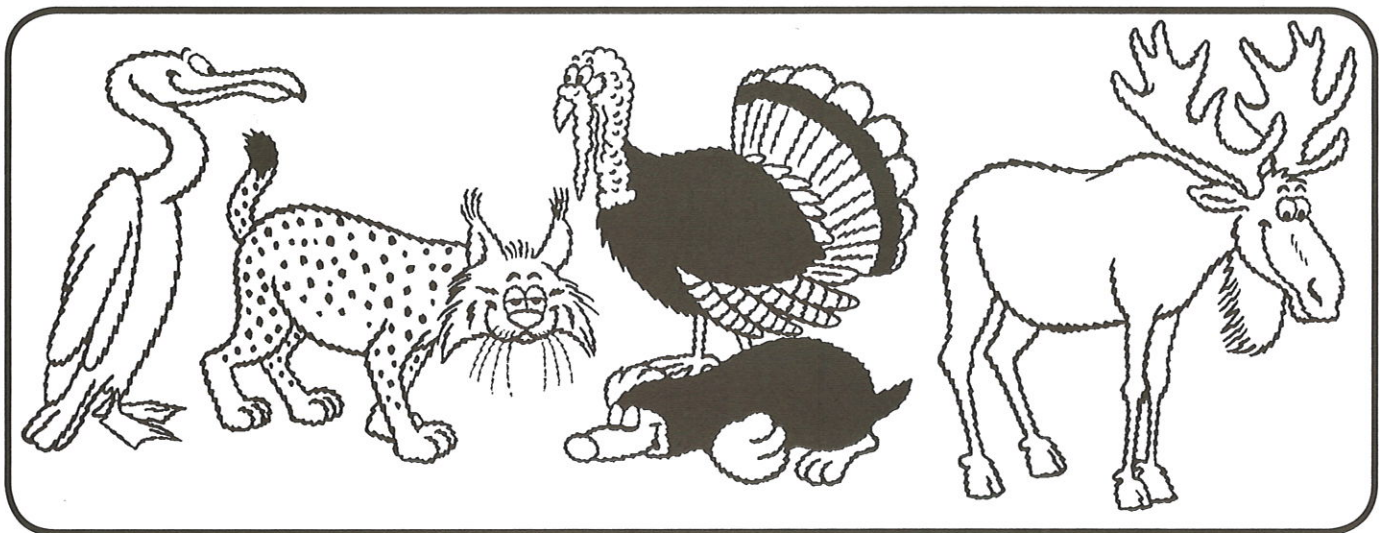
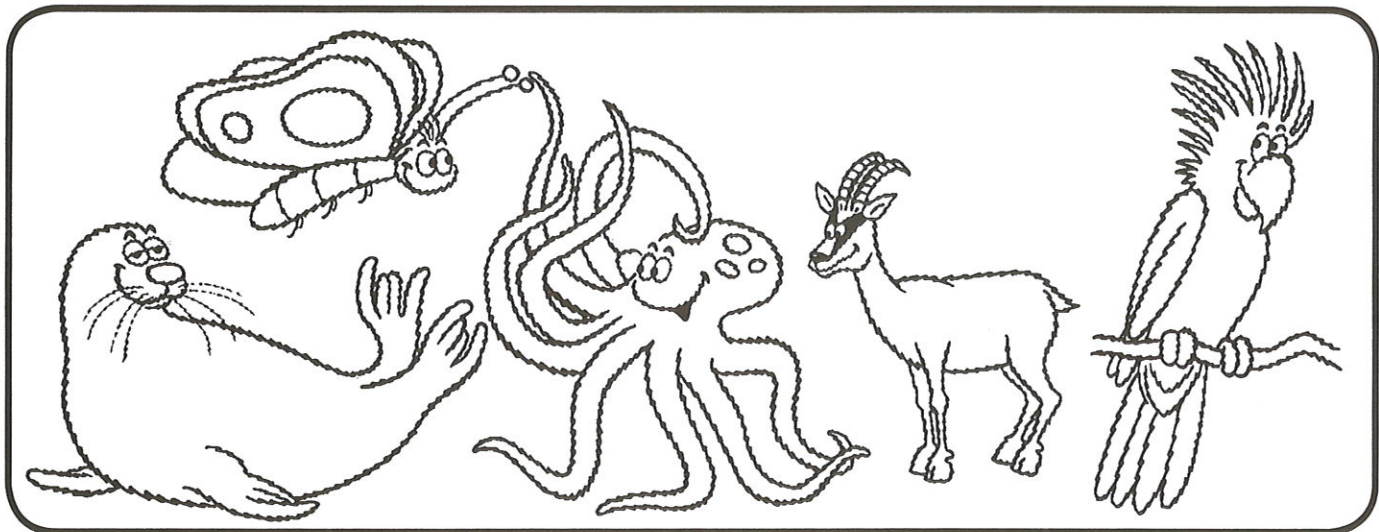





# KOČIČKA MICINKA

Micinka pořád spí! Vybarvi písmenka, která potřebuješ pro vytvoření jména Micinka, a zbytečná písmenka škrtni.



# Slabiky

Vyslov slovo na obrázku. Vytleskej slovo podle slabik.

Na linku pod obrázek udělej tolik čárek, kolik má slovo slabik.

Obrázky vybarvi.

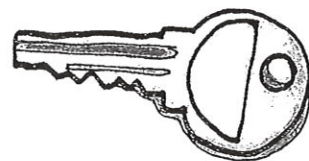
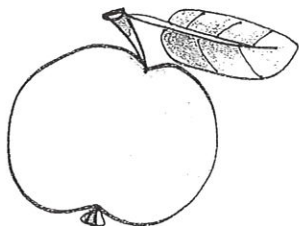

Vzor: ||

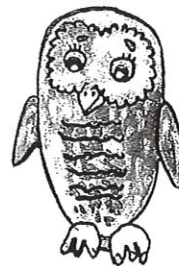
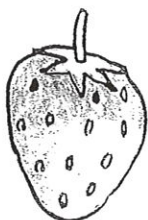
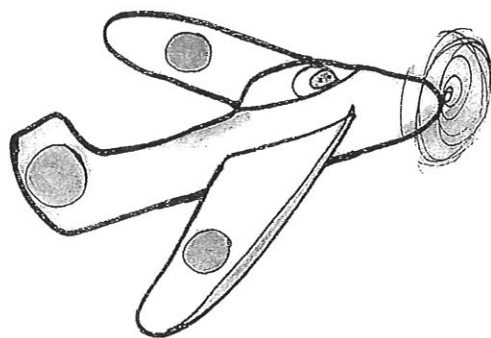
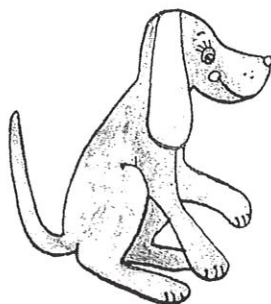
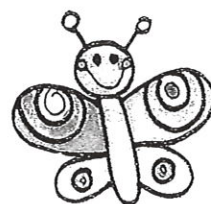
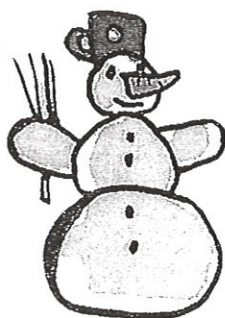



Očísľuj fáze Matějova převlékání.

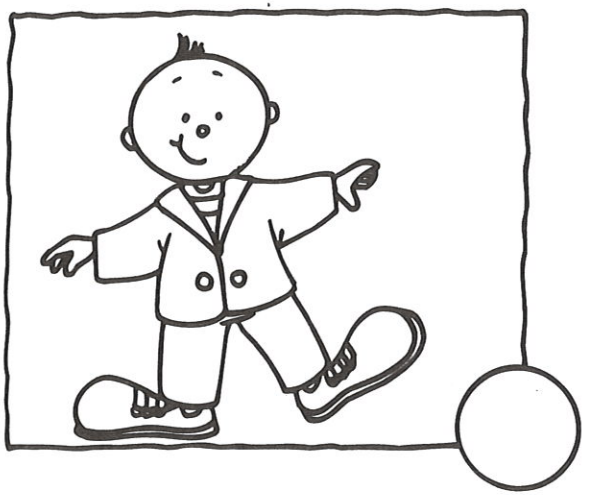
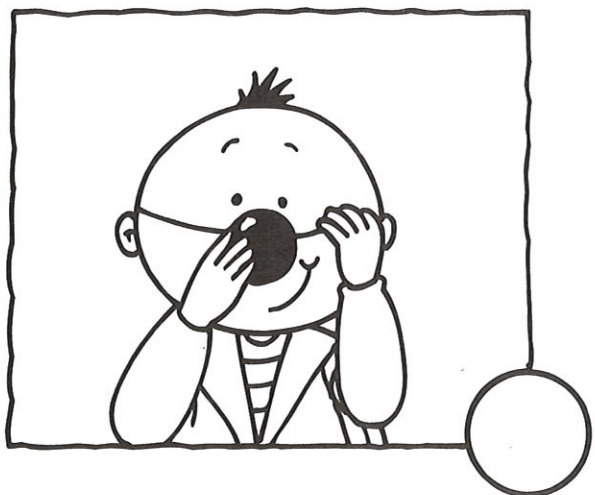
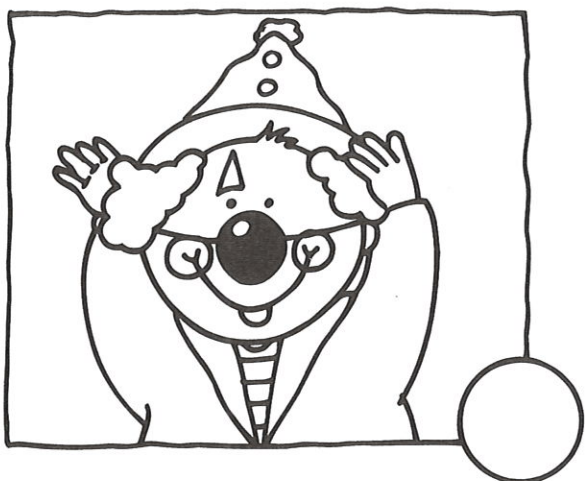
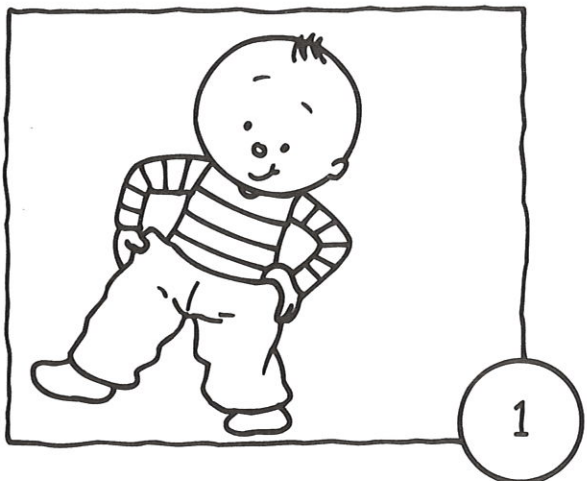
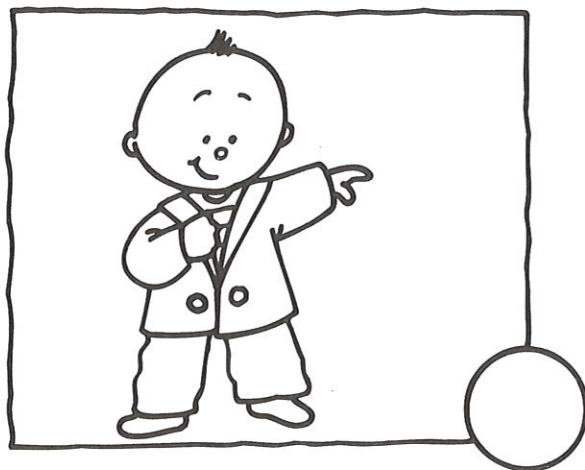
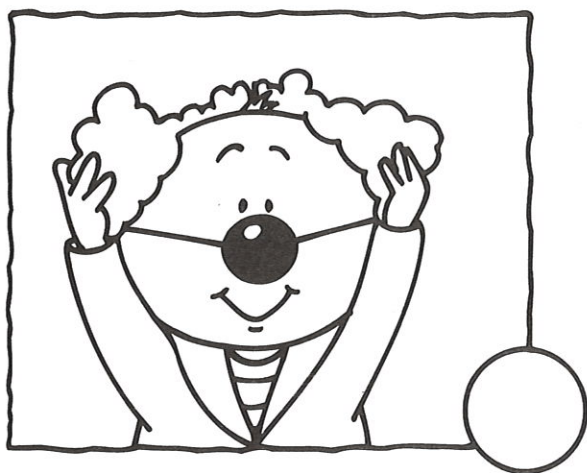

Vybarvi vždy menší porci.

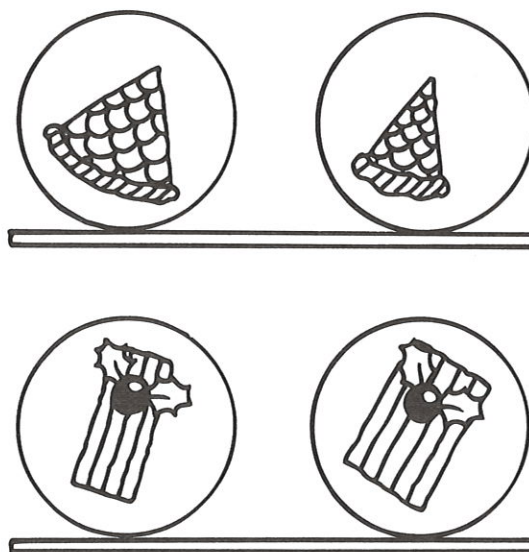
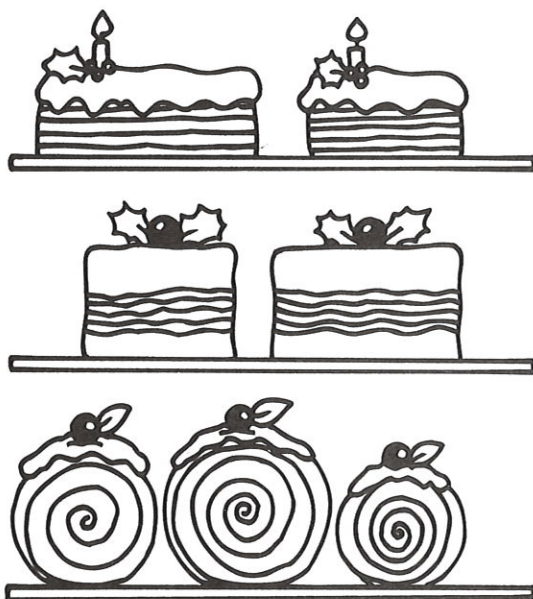

Nakresli vždy méně cukroví, než je v již nakreslené části.

